

Series **900A**

product guide

features

- **103' Four-Section Boom**
- **26 Ton Rating**
- **Self-lubricating "Easy Glide" Wear Pads**
- **Internal Anti-two-block**



contents

Features

2

Mounting Configurations

3

Specifications

4

Capacities: With 44' Jib

5

Capacities: No Jib

6

Accessories

7

features

Why Buy a National Series 900A?

2



*Product may be shown with optional equipment.

- **26 ton Rating** – The 900A provides a 26-ton capacity.
- **New 103 ft. Four-section Boom** – The longest in its size range. The longer boom allows the operator to perform more lifts without the use of a jib, reducing setup time and improving efficiency.
- **Self-lubricating “Easy glide” Wear Pads** – The self-lubricating pads, standard on the 900A reduce the conditions that cause boom chatter and vibration. The net result is smoother crane operation.
- **Internal Anti-two-block** – The patent-pending design, standard on the 900A eliminates the external reel and wire. No more snagging reel or wire on obstructions.
- **Adjustable Swing Speed** – A control knob located on the swing motor brake release valve can be easily adjusted to the crane operator’s swing speed preference.
- **Speedy-reeve Boom Tip and Sheave Blocks** – These standard features simplify rigging changes.
- **Pre-painted Components** – Painting crane components before assembly reduces the possibility of rust, improves serviceability and enhances the appearance of the machine.
- **Burst-of-Speed Winch** – Provides faster winch payout and pickup of unloaded cable.
- **Improved Serviceability** –
 - A removable winch allows the internal telescoping cylinder to be removed quickly, without dismantling the boom.
 - Bearings on the boom extend and retract cables can be greased through access holes in the boom side plates.
 - Internal anti-two-block wire routing eliminates damage potential.
 - The boom sheave case is open, allowing access to replace the internal anti-two-block wire and to observe internal boom components.
 - Pre-paint reduces rust.
 - Internal boom parts have been reduced, decreasing service time when rebuilding the machine.
- **National Crane Is the Market Leader** – National is number one in the production of commercial truck-mounted boom trucks.
 - National has the boom truck industry’s leading test program. Every structural part of the crane is fully life cycle tested at full capacity. In addition to cycle testing, each model is subjected to state-of-the-art strain gauge testing that measures metal deformation as small as one-millionth of an inch. The net result is that weak areas are caught in test, not on job sites where costly downtime occurs.
 - All outrigger, lift and telescoping cylinders are manufactured to National Crane Designs, so that the seals, packing glands, and end plates are traced for accurate shipment of replacement parts.
 - National has a formalized quality program and is ISO 9001 approved.
- **National Crane Is a Quality Product That Will Provide Years of Service**
 - Parts are available for all National Crane machines, even if they are over 20 years old.

- 26-ton (23.6-t) maximum capacity
- 156 ft. (47.5 m) maximum vertical reach*
- 112 ft. (34.1 m) maximum vertical hydraulic reach*
- Hydraulic Capacity Alert system (HCA) or Load Moment Indicator System (LMI)
- Proportional boom extension
- High performance planetary winch
- Heavy-duty triple pump hydraulics
- * Maximum vertical reach is ground-level to boom tip height at maximum extension and angle with outriggers/stabilizers fully extended.

900A

mounting configurations

The configurations are based on the Series 900A with an 85% stability factor. The complete unit must be installed in accordance with factory requirements and a test performed to determine actual stability and counterweight requirements since individual truck chassis vary.

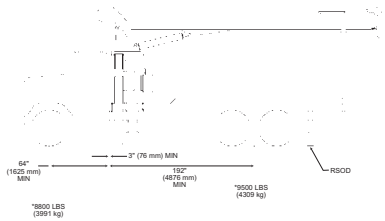

Configuration 1 - 9103A

Working area	180"
Gross Axle Weight Rating Front	16,000 lb (7257 kg)
Gross Axle Weight Rating Rear	34,000 lb (15 422 kg)
Gross Vehicle Weight Rating	50,000 lb (22 679 kg)
Wheelbase	256 in (650 cm)
Cab to Axle/trunnion (CA/CT)	192 in (488 cm)
Frame Section Modulus (SM) under crane: 110,000 PSI (758 MPa)	20 in ³ (327 cm ³)
Frame Section Modulus (SM) over rear stabilizers: 110,000 PSI (758 MPa)	15 in ³ (245 cm ³)
Stability Weight, Front	8,800 lb (3991 kg) minimum*
Stability Weight, Rear	9,500 lb (4309 kg) minimum*
Estimated Average Final Weight	42,600 lb (19 323 kg)

3

This configuration allows the installation of the Series 9103A on a chassis by using the subbase for a 22-ft (6.71-m) bed.

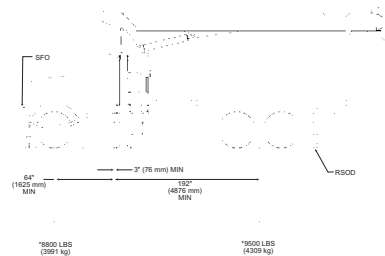

Configuration 2 - 9103A with SFO

Working area	360"
Gross Axle Weight Rating Front	16,000 lb (7257 kg)
Gross Axle Weight Rating Rear	34,000 lb (15 422 kg)
Gross Vehicle Weight Rating	50,000 lb (22 679 kg)
Wheelbase	256 in (650 cm)
Cab to Axle/trunnion (CA/CT)	192 in (488 cm)
Frame Section Modulus (SM) under crane: 110,000 PSI (758 MPa)	20 in ³ (327 cm ³)
Frame Section Modulus (SM) over rear stabilizers: 110,000 PSI (758 MPa)	15 in ³ (245 cm ³)
Stability Weight, Front	8,800 lb (3991 kg) minimum*
Stability Weight, Rear	9,500 lb (4309 kg) minimum*
Estimated Average Final Weight	42,900 lb (19 459 kg)

This mount requires front stabilizer for full capacity 360° around the truck. Front stabilizer gives the machine a solid base, helping the operator control loads.

This configuration requires a 22-ft (6.71-m) bed.

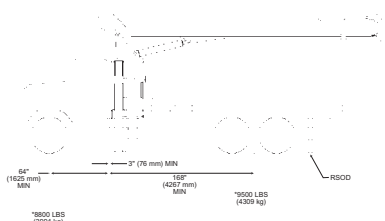

Configuration 3 - 990A / 969A

Working area	180"
Gross Axle Weight Rating Front	16,000 lb (7257 kg)
Gross Axle Weight Rating Rear	34,000 lb (15 422 kg)
Gross Vehicle Weight Rating	50,000 lb (22 679 kg)
Wheelbase	232 in (589 cm)
Cab to Axle/trunnion (CA/CT)	168 in (427 cm)
Frame Section Modulus (SM) under crane: 110,000 PSI (758 MPa)	20 in ³ (327 cm ³)
Frame Section Modulus (SM) over rear stabilizers: 110,000 PSI (758 MPa)	15 in ³ (245 cm ³)
Stability Weight, Front	8,800 lb (3991 kg) minimum*
Stability Weight, Rear	9,500 lb (4309 kg) minimum*
Estimated Average Final Weight	40,600 lb (18 415 kg)

This configuration allows the installation of the Series 990A or 969A on a chassis with a small frame by using a subbase for a 20-ft (6.10-m) bed or a different subbase for a 22-ft (6.71-m) bed.

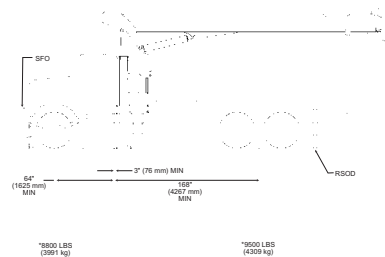

Configuration 4 - 990A / 969A with SFO

Working area	360"
Gross Axle Weight Rating Front	16,000 lb (7257 kg)
Gross Axle Weight Rating Rear	34,000 lb (15 422 kg)
Gross Vehicle Weight Rating	50,000 lb (22 679 kg)
Wheelbase	232 in (589 cm)
Cab to Axle/trunnion (CA/CT)	168 in (427 cm)
Frame Section Modulus (SM) under crane: 110,000 PSI (758 MPa)	20 in ³ (327 cm ³)
Frame Section Modulus (SM) over rear stabilizers: 110,000 PSI (758 MPa)	15 in ³ (245 cm ³)
Stability Weight, Front	8,800 lb (3991 kg) minimum*
Stability Weight, Rear	9,500 lb (4309 kg) minimum*
Estimated Average Final Weight	40,900 lb (18 551 kg)

This configuration allows the installation of the 990A or 969A on a chassis by using a subbase for a 20-ft (6.10-m) bed or a different subbase for a 22-ft (6.71-m) bed. This mount requires front stabilizer for full capacity 360° around the truck.

Front stabilizer gives the machine a solid base, helping the operator control loads.

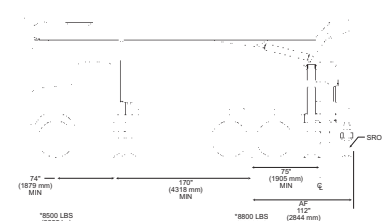

Configuration 5 - Rear Mount

Working area	360"
Gross Axle Weight Rating Front	16,000 lb (7257 kg)
Gross Axle Weight Rating Rear	40,000 lb (18 143 kg)
Gross Vehicle Weight Rating	56,000 lb (25 401 kg)
Wheelbase	244 in (620 cm)
Cab to Axle/trunnion (CA/CT)	MINIMUM 170 in (432 cm)
Frame Section Modulus (SM) under crane: 110,000 PSI (758 MPa)	15.9 in ³ (260 cm ³)
Stability Weight, Front	8,500 lb (3855 kg) minimum*
Stability Weight, Rear	7,000 lb (3991 kg) minimum*
Estimated Average Final Weight	43,000 lb (19 504 kg)

This configuration allows the rear-mount installation of the Series 900A. This configuration is 360° stable and allows the effective use of close working area to lift the heavier capacity loads. Maximum bed length is 16 ft (4.87 m).

Notes:

- Gross Vehicle Weight Rating (GVWR) is dependent on all components of the vehicle (axles, tires, springs, frame, etc.) meeting manufacturers' recommendations; always specify GVWR when purchasing trucks
- Diesel engines require a variable speed governor and energize-to-run fuel solenoid for smooth crane operation; electronic fuel injection requires EET engine remote throttle

- All mounting data is based on a National Series 900A with an 85 percent stability factor
- The complete unit must be installed in accordance with factory requirements, and a test performed to determine actual stability and counterweight requirements per SAE J765; contact the factory for details
- Transmission neutral safety interlock switch is required with optional remote control

*Estimated axle scale rates prior to installation of crane, stabilizers and subbase for 85% stability.

900A

specifications

Boom and Jib Combinations Data

Available in four basic models.

4 Model 969A – Equipped with a 27 ft 6 in to 69 ft 2 in (8.38-21.08m) three-section boom. This model can be equipped with a 25-44 ft (7.62-13.41 m) two-section jib. Maximum tip height w/ 44 ft (13.41 m) jib is 123 ft 9 in (37.71 m).

27'6" - 69'2" (8.38-21.08 m) three-section boom



27'6" - 69'2" (8.38-21.08 m) three-section boom **9FJ44M** 25-44 ft (7.62-13.41 m) two-section jib



Model 990A – Equipped with a 27 ft 6 in to 90 ft 6 in (8.38-27.58 m) four-section boom. This model can be equipped with a 21 ft (6.40 m) single section wireline jib or a 25-44 ft (7.62-13.41 m) two-section jib. Maximum tip height w/ 44 ft (13.41 m) jib is 143 ft (43.58 m).

27'6" - 90'6" (8.38-27.58 m) four-section boom



27'6" - 90'6" (8.38-27.58 m) four-section boom **9FJ44M** 25-44 ft (7.62-13.41 m) two-section jib



Model 9103A – Equipped with a 30 ft 9 in to 102 ft 10 in (9.37-31.34 m) four-section boom. This model can be equipped with a 25-44 ft (7.62-13.41 m) two-section jib. Maximum tip height w/ 44 ft (13.41 m) jib is 155 ft (47.24 m).

30'9" - 102'10" (9.37-31.34 m) four-section boom



30'9" - 102'10" (9.37-31.34 m) four-section boom **9FJ44M** 25-44 ft (7.62-13.41 m) two-section jib



Model 9125A – Equipped with a 36 ft 2 in to 125 ft (11.02-38.10) four-section boom. Maximum tip height is 134 ft (40.84 m).

36'2" - 125' (11.02-38.10 m) four-section boom









Note: maximum tip height is measured with outriggers/stabilizers fully extended.

900A Winch Data

900A Winch Data

- All winch pulls and speeds in this chart are shown on the fourth layer
- Winch line pulls would increase on the first, second and third layers
- Winch line speed would decrease on the first, second and third layers
- Winch line pulls may be limited by the winch capacity or the ANSI 5 to 1 cable safety factor
- Hook blocks are rated at maximum capacity for the block. **Do not exceed rated cable pull with any block.**

Winch	Cable Supplied	Avg. Breaking Strength	1 Part Line	2 Part Line	3 Part Line	4 Part Line	5 Part Line	6 Part Line	7 Part Line
Standard Planetary Winch	9/16" Diameter Rotation Resistant	38,500 lb (17 463 kg)							
			Lift and Speed	Lift and Speed	Lift and Speed	Lift and Speed	Lift and Speed	Lift and Speed	Lift and Speed
			7,700 lb (3 492 kg) 135 fpm (41 m/m)	15,400 lb (6 985 kg) 68 fpm (20 m/m)	23,100 lb (10 477 kg) 45 fpm (13 m/m)	30,800 lb (13 970 kg) 34 fpm (10 m/m)	38,500 lb (17 463 kg) 27 fpm (8 m/m)	46,200 lb (20 955 kg) 23 fpm (7 m/m)	52,000 lb (23 586 kg) 19 fpm (5 m/m)
With "Burst-of-Speed"	Same as corresponding cable data shown above		3,000 lb (1 360 kg) 206 fpm (62 m/m)	6,000 lb (2 721 kg) 103 fpm (31 m/m)	9,000 lb (4 082 kg) 64 fpm (19.51 m/m)	12,000 lb (5 443 kg) 51 fpm (15 m/m)	15,000 lb (6 803 kg) 41 fpm (12 m/m)	18,000 lb (8 164 kg) 34 fpm (10 m/m)	21,000 lb (9 525 kg) 29 fpm (8 m/m)

Winch	Bare Drum Pull	Allowable Cable Pull
With standard rotation resistant rope	10,200 lb (4627 kg)	7,700 lb (3493 kg)

Block Type	Rating	Weight
Downhaul Weight	3.85 ton (3.49 t)	150 lb (68 kg)
1 Sheave Block	11.55 ton (10.48 t)	305 lb (138 kg)
2 Sheave Block	19.25 ton (17.46 t)	355 lb (161 kg)

900A

Load Rating Chart: Series 9103A with 44 ft. Jib

Other Series 900A Load Rating Charts are available. National will send you a chart on request – or you may secure needed load rating information through your nearest National dealer.

5

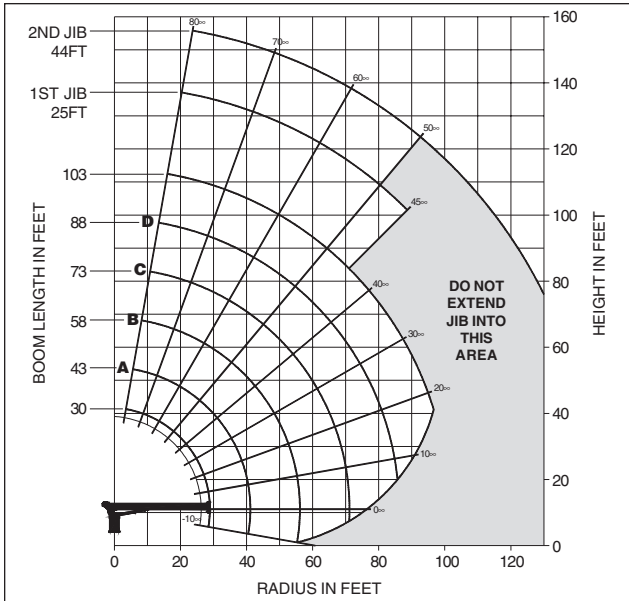

CAUTION:

- Do not operate crane booms, jib extensions, any accessories or loads within 10 ft (3m) of live power lines or other conductors of electricity.
- Jib and boom capacities shown are maximum for each section.
- Do not exceed capacities at reduced radii
- Load ratings shown on the load rating charts are maximum allowable loads with the outriggers properly extended on a firm, level surface and the crane leveled and mounted on a factory recommended truck.
- Always level the crane with the level indicator located on the crane.
- The operator must reduce load to allow for factors such as wind, ground conditions, operating speeds and their effects on freely suspended loads.
- Overloading this crane may cause structural collapse or instability.
- Weights on any accessories attached to the boom or loadline must be deducted from the load chart capacities.
- Do not exceed jib capabilities at any reduced boom lengths.
- Do not deadhead lineblock against boom tip when extending boom or winching up.
- Keep at least three wraps of loadline on drum at all times.
- Use only specified cable with this machine.

SERIES 9103A WITH 44 FT JIB LMI CAPACITIES

NOTE:

1. Operate with jib by radius when main boom is fully extended. If necessary increase boom angle to maintain loaded radius.
2. Operate with jib by boom angle when main boom is not fully extended. Do not exceed rated jib capacities at any reduced boom lengths.
3. Capacities do not exceed 85% stability.
4. Shaded areas are structurally limited capacities.

LMI OPERATING CODE SWITCH

SWITCH POSITION	OPERATING MODE
01	MAIN BOOM - NO JIB STOWED
02	MAIN BOOM - JIB STOWED
03	25 FT TELE JIB
04	44 FT TELE JIB
11	MAN BASKET ON MAIN BOOM
12	MAN BASKET ON 25 FT TELE JIB
13	MAN BASKET ON 44 FT TELE JIB

Load Rating: Series 9103A with 44 ft. Jib

LOAD RADIUS (FEET)	LOADED BOOM ANGLE	30FT BOOM (lb)	LOADED BOOM ANGLE	A 43FT BOOM (lb)	LOADED BOOM ANGLE	B 58FT BOOM (lb)	LOADED BOOM ANGLE	C 73FT BOOM (lb)	LOADED BOOM ANGLE	D 88FT BOOM (lb)	LOADED BOOM ANGLE	103FT BOOM (lb)
5	78.5	52,000										
8	72.5	34,850										
10	68.5	29,050	75.5	26,400	80	24,950						
12	64.5	24,750	72.5	22,500	78	21,250						
14	60	21,250	69.5	19,600	76	19,350	79.5	17,750				
16	55.5	18,950	67	17,300	74	16,350	78	15,350	80	14,300		
20	45	14,350	60.5	14,000	69	13,750	74	12,650	77.5	11,700	80	10,550
25			52	10,800	63.5	10,550	70	10,150	74	9,400	77	9,100
30			42.5	8,500	57.5	8,500	65.5	8,350	70.5	7,750	74.5	7,150
35			32.5	6,500	52.5	6,900	62	6,800	67.5	6,400	71.5	6,050
40					45.5	5,650	57	5,600	64	5,450	68.5	5,150
45					38	4,500	52	4,700	60	4,600	65.5	4,500
50					28	3,450	46.5	3,950	56	3,950	62	3,900
55							40.5	3,150	52	3,300	59	3,350
60							34	2,550	47.5	2,750	55.5	2,900
65									42.5	2,200	52	2,450
70									37.5	1,750	48	2,050
75									31	1,350	44	1,650
80											39.5	1,250
85											34.5	900
	0	4,500	0	2,200	0	800						
ADD TO CAPACITIES WHEN NO JIB STOWED (lb)		850		600		450		350		300		250

LOAD RADIUS (FEET)	LOADED BOOM ANGLE	25FT JIB (lb)	LOADED BOOM ANGLE	44FT JIB (lb)
30	76.5	3,950		
35	74.5	3,450	76.5	2,550
40	72	3,050	75	2,500
45	70	2,600	73	2,450
50	67.5	2,250	71	2,250
55	65	1,950	69	1,850
60	62.5	1,800	67	1,650
65	60	1,550	64.5	1,350
70	57.5	1,300	62.5	1,200
75	54.5	1,100	60	1,050
80	51.5	900	58	950
85	48.5	700	55.5	900
90	45.5	450	53	750
95			50.5	600

LOADLINE EQUIPMENT DEDUCT (lb)

- Downhaul weight _____ 150
- One sheave block _____ 305
- Two sheave block _____ 355
- Three sheave block _____ 575

THIS CHART IS ONLY A GUIDE AND SHOULD NOT BE USED TO OPERATE THE CRANE. The individual crane's load chart, operating instructions and other instructional plates must be read and understood prior to operating the crane.

capacities

Load Rating Chart: Series 9103A with No Jib

Other Series 900A Load Rating Charts are available. National will send you a chart on request – or you may secure needed load rating information through your nearest National dealer.

6

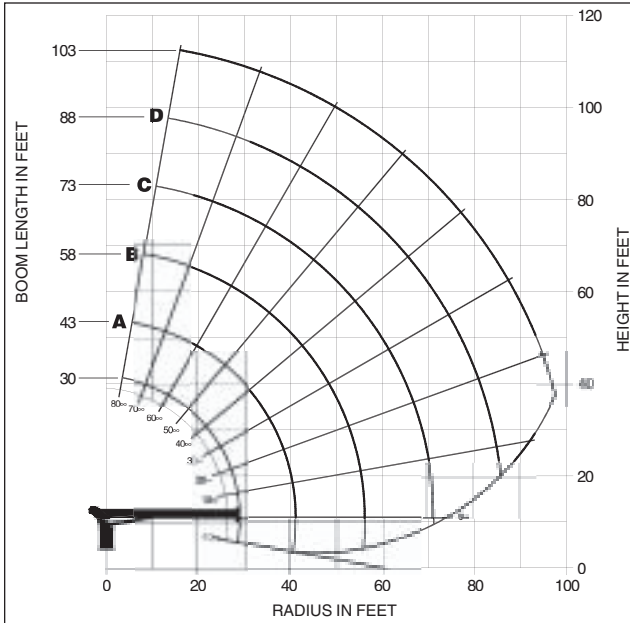

CAUTION:

- Do not operate crane booms, jib extensions, any accessories or loads within 10 ft (3m) of live power lines or other conductors of electricity.
- Jib and boom capacities shown are maximum for each section.
- Do not exceed capacities at reduced radii
- Load ratings shown on the load rating charts are maximum allowable loads with the outriggers properly extended on a firm, level surface and the crane leveled and mounted on a factory recommended truck.
- Always level the crane with the level indicator located on the crane.
- The operator must reduce load to allow for factors such as wind, ground conditions, operating speeds and their effects on freely suspended loads.
- Overloading this crane may cause structural collapse or instability.
- Weights on any accessories attached to the boom or loadline must be deducted from the load chart capacities.
- Do not exceed jib capabilities at any reduced boom lengths.
- Do not deadhead lineblock against boom tip when extending boom or winching up.
- Keep at least three wraps of loadline on drum at all times.
- Use only specified cable with this machine.

**SERIES 9103A
WITH
NO JIB**

LOADLINE EQUIPMENT DEDUCT (lb.)	
Downhaul weight	150
One sheave block	305
Two sheave block.....	355
Three sheave block	575

LMI OPERATING CODE SWITCH	
SWITCH POSITION	OPERATING MODE
01	MAIN BOOM - NO JIB STOWED
11	MAN BASKET ON MAIN BOOM

Load Rating: Series 9103A with No Jib

LOAD RADIUS (FEET)	LOADED BOOM ANGLE	30FT BOOM (lb)	LOADED BOOM ANGLE	A 43FT BOOM (lb)	LOADED BOOM ANGLE	B 58FT BOOM (lb)	LOADED BOOM ANGLE	C 73FT BOOM (lb)	LOADED BOOM ANGLE	D 88FT BOOM (lb)	LOADED BOOM ANGLE	103FT BOOM (lb)
5	78.5	52,000										
8	72.5	35,700										
10	68.5	29,900	75.5	27,000	80	25,400						
12	64.5	25,600	72.5	23,100	78	21,700						
14	60	22,100	69.5	20,200	76	19,800	79.5	18,100				
16	55.5	19,800	67	17,900	74	16,800	78	15,700	80	14,600		
20	45	15,200	60.5	14,600	69	14,200	74	13,000	77.5	12,000	80	10,800
25			52	11,400	63.5	11,000	70	10,500	74	9,700	77	9,350
30			42.5	9,100	57.5	8,950	65.5	8,700	70.5	8,050	74.5	7,400
35			32.5	7,100	52.5	7,350	62	7,150	67.5	6,700	71.5	6,300
40					45.5	6,100	57	5,950	64	5,750	68.5	5,400
45					38	4,950	52	5,050	60	4,900	65.5	4,750
50					28	3,900	46.5	4,300	56	4,250	62	4,150
55							40.5	3,500	52	3,600	59	3,600
60							34	2,900	47.5	3,050	55.5	3,150
65									42.5	2,500	52	2,700
70									37.5	2,050	48	2,300
75									31	1,650	44	1,900
80											39.5	1,500
85											34.5	1,150
	0	5,350	0	2,800	0	1,250						

900A

THIS CHART IS ONLY A GUIDE AND SHOULD NOT BE USED TO OPERATE THE CRANE. The individual crane's load chart, operating instructions and other instructional plates must be read and understood prior to operating the crane.

Radio Remote Controls –

Eliminate the handling and maintenance concerns that accompany cabled remotes. Operate to a range of about 250 feet (76 m), varying with conditions.

- **Model NB4R** (R4 functions)

One-Person Basket –

Strong but lightweight steel basket with 300-lb. (139-kg) capacity, gravity hung with swing lock and full body harness.

- **Model B1-S**
- **Model 2B1-S** (for dual locking baskets)

Heavy-duty Personnel Basket –

1,200-lb. (544-kg) capacity steel basket with safety loops for four passengers. Gravity leveling 72- x 42-inch (183- x 107-cm) platform. Fast attachment and secure locking systems. Load chart must show 2,300 (1043 kg) minimum to operate this accessory.

- **Model BSA-1**
- **Model BSA-R1** (provides rotation)

Hydraulic Oil Cooler –

Automatic, self-contained radiator system with electric fans, cools oil under continuous duty-cycle operations.

- **Model OC**

Continuous Rotation –

Allows rotation of turret/boom without stop.

- **Model CR**

Dimensions Specifications

Model	Capacity (lb.)	Capacity (kg)	Platform (in.)	Platform (cm)	Height (in.)	Height (cm)
Model B1-S	300	139	72 x 42	183 x 107	100	2540
Model 2B1-S	300	139	72 x 42	183 x 107	100	2540
Model BSA-1	1200	544	72 x 42	183 x 107	100	2540
Model BSA-R1	1200	544	72 x 42	183 x 107	100	2540

INCLUDES PLATFORM, HOISTING, AND LOCKING SYSTEMS.
HEIGHTS OF PLATFORM TO TURRET.

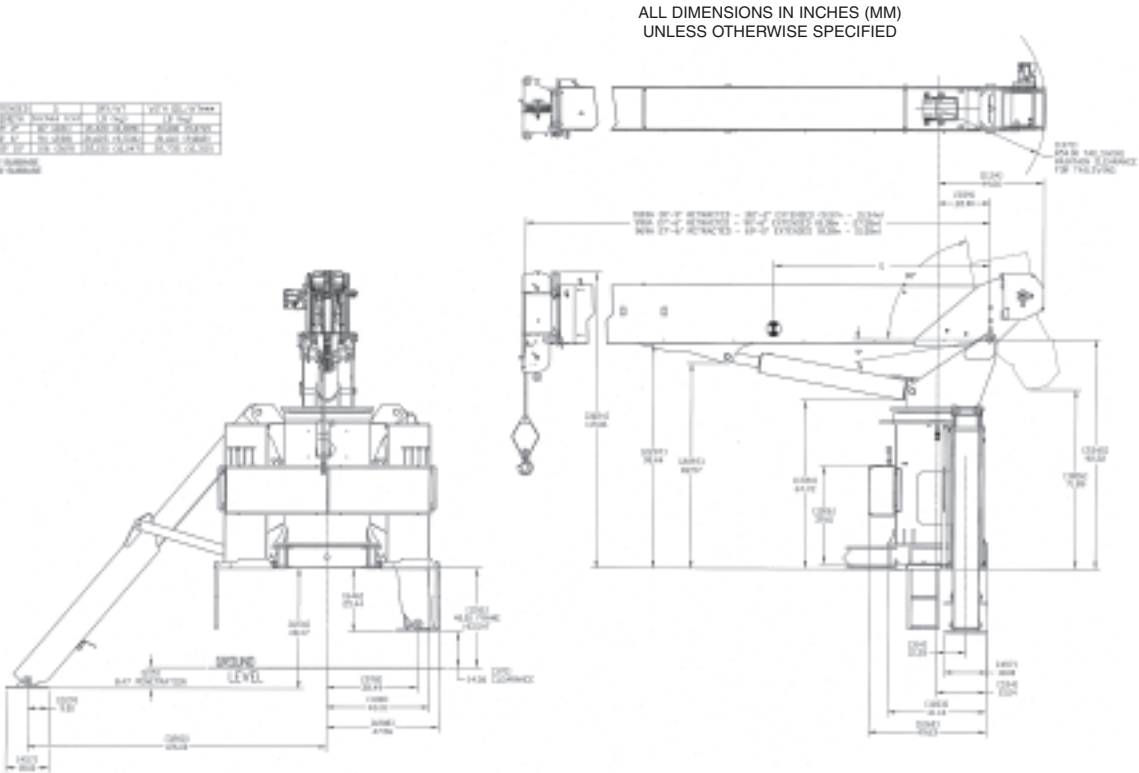

THIS CHART IS ONLY A GUIDE AND SHOULD NOT BE USED TO OPERATE THE CRANE. The individual crane's load chart, operating instructions and other instructional plates must be read and understood prior to operating the crane.



Manitowoc Crane Group - Americas

Manitowoc, Wisconsin Facility
Tel: [Int + 001] 920 684 6621
Fax: [Int + 001] 920 683 6277
Shady Grove, Pennsylvania Facility
Tel: [Int + 001] 717 597 8121
Fax: [Int + 001] 717 597 4062

Manitowoc Crane Group - EMEA

Europe Middle East & Africa
Tel: [Int + 33] (0) 191 565 6281
Fax: [Int + 33] (0) 4 72 18 20 20

Manitowoc Crane Group - UK

Europe Middle East & Africa
Tel: [Int + 44] (0) 191 565 6281
Fax: [Int + 44] (0) 191 564 0442

Manitowoc Crane Group - Germany

(Sales, Parts & Service)
Tel: [Int + 49](0) 2173 8909 0
Fax: [Int + 49] (0) 2173 8909-30

Manitowoc Crane Group - France

France & Africa (Sales, Parts & Service)
Tel: [Int + 33] (0) 1 303 13150
Fax: [Int + 33] (0) 1 303 86085

Manitowoc Crane Group - Netherlands

(Sales, Parts & Service)
Tel: [Int + 31] (0) 76 578 39 99
Fax: [Int + 31] (0) 76 578 39 78

Manitowoc Crane Group - Italy

Italy & Southern Europe (Sales, Parts & Service)
Tel: [Int + 39] (0) 331 49 33 11
Fax: [Int + 39] (0) 331 49 33 30

Manitowoc Crane Group - Portugal

Portugal & Spain (Sales, Parts & Service)
Tel: [Int + 351] (0) 22 968 08 89
Fax: [Int + 351] (0) 22 968 08 97

Manitowoc Crane Group - Singapore

Asia/Pacific excl China (Sales, Parts & Service)
Tel: [Int + 65] 6861 1733
Fax: [Int + 65] 6862 4040 / 4142

Manitowoc Crane Group - Shanghai

China (Sales, Parts & Service)
Tel: [Int + 86] (0) 21 64955555
Fax: [Int + 86] (0) 2164852038

Manitowoc Crane Group - Beijing

China (Sales, Parts & Service)
Tel: [Int + 86] (0) 10 646 71690
Fax: [Int + 86] (0) 10 646 71691

Manitowoc Crane Group - Middle East

Sales
Tel: [Int + 971] (0) 4 348 4478
Fax: [Int + 971] (0) 4 348 4478
(Parts & Service)
Tel: [Int + 973] (0) 9 660 899
Fax: [Int + 973] (0) 2 707 740

Distributed By:



www.manitowoccrane.com

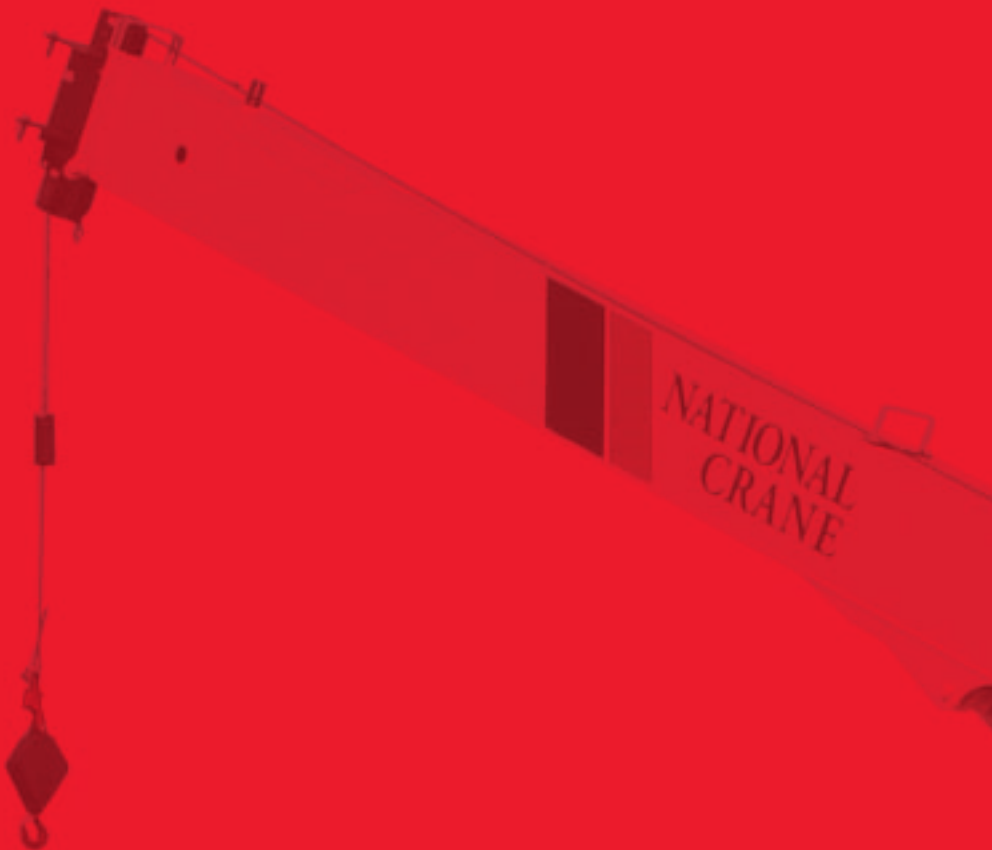

Constant improvement and engineering progress make it necessary that we reserve the right to make specification, equipment, and price changes without notice. *Illustrations/photos shown may include optional equipment and accessories, and may not include all standard equipment.