

# Series **800D**

## **product guide**

### features

- 100' Four-Section Boom
- 23 Ton Rating
- Self-lubricating "Easy Glide" Wear Pads
- Internal Anti-two-block



### contents

Features

2

Mounting Configurations

3

Specifications

4

Capacities: With 44' Jib

5

Capacities: No Jib

6

Accessories

7

# features

## Why Buy a National Series 800D?

2



- **23-ton Rating** – The 800D is now a 23-ton machine, a 10.5% increase in capacity over the Series 800C.
- **100-foot Four-section Boom** – The longest in its size range. The longer boom allows the operator to perform more lifts without the use of a jib, reducing setup time and improving efficiency.
- **Overload Protection** – All National cranes are equipped with overload protection:
  - Load Moment Indicator (LMI) required on all machines equipped with jibs or personnel baskets.
  - LMI or Hydraulic Capacity Alert System (HCA) required with ordering machine without jib or personnel basket.
- **Internal Anti-two-block Wire** – The patent-pending design, standard on the 800D, routes the wire through the inside of the boom. No more snagging the wire on obstructions.
- **Self-lubricating “Easy glide” Wear Pads** – The self-lubricating pads, used in conjunction with National’s specially formulated paint, reduce the conditions that cause boom chatter and vibration. The net result is smoother crane operation.
- **Adjustable Swing Speed** – Standard on the 800D. A control knob located on the swing motor brake release valve can be easily adjusted to the crane operator’s swing speed preference.
- **Heavier Duty Torsion Box** – The stronger standard torsion box improves rigidity, reduces truck frame flex and reduces the need for counterweight.
- **Speedy-Reeve Boom Tip and Sheave Blocks** – These standard features simplify rigging changes. Load line wedge socket removal not required for reeving of multi-part line options.
- **Pre-painted Components** – Painting crane components before assembly reduces the possibility of rust, improves serviceability and enhances the appearance of the machine.
- **Improved Serviceability and Reliability** –
  - Sheave bearings on the boom extend and retract cables can be greased through access holes in the boom side plates.
  - The number of internal boom parts has been reduced, facilitating rebuilding the machine.
- **New State-of-the-Art Control Valve** – Provides smoother operation. The new design eliminates parts, reducing repair costs and improving the machine’s serviceability.
- **National Crane Is the Market Leader** – National is number one in the production of commercial truck-mounted boom trucks. National has the resources, programs and people to provide our customers with reliable products.
- **National has the boom truck industry’s leading test program** – The Series 800D is a completely new design that has been through a strenuous months-long testing regimen. Structural parts of the crane have been cycle tested up to 60,000 cycles at full capacity. In addition to cycle testing, each model has been subjected to intensive strain gauge testing that measures metal deformation as small as one one-millionth of an inch. The net result is that any weak areas are caught in test, not on job sites where costly downtime occurs.
- Parts are available for all National Crane machines, even if they are 35 years old.
- National has a formalized quality program and is ISO 9001 certified.
- **You Expect National Crane to be a Quality Product That Will Provide Years of Service, and So Do We.**

- 23-ton (20.87-t) maximum capacity
- 152 ft. (46.32-m) maximum vertical reach\*
- 109-ft. (33.22-m) maximum vertical hydraulic reach\*
- Load Moment Indicator System (LMI) or Hydraulic Capacity Alert System (HCA)
- Proportional boom extension
- High performance planetary winch
- Heavy-duty triple pump hydraulics
- \* Maximum vertical reach is ground-level to boom tip height at maximum extension and angle with outriggers/stabilizers fully extended.

800D

# mounting configurations

3

The configurations are based on the Series 800D with an 85% stability factor. The complete unit must be installed in accordance with factory requirements and a test performed to determine actual stability and counterweight requirements since individual truck chassis vary. Trucks with a frame height in excess of 42 inches (107 cm) after mounting will have a final mounted unit height more than 13' 6" (411.5 cm). Chassis that do not meet these minimum stability weights may require counterweight.

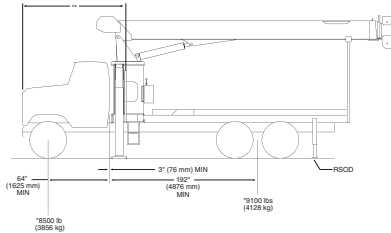

## Configuration 1 – 8100D

Working area	180°
Gross Axle Weight Rating Front	16,000 lb (7257 kg)
Gross Axle Weight Rating Rear	34,000 lb (15 422 kg)
Gross Vehicle Weight Rating	50,000 lb (22 679 kg)
Wheelbase	256 in (650 cm)
Cab to Axle/trunnion (CA/CT)	192 in (488 cm)
Frame Section Modulus (SM) under crane: 110,000 PSI (758 MPa)	15.9 in <sup>3</sup> (260.6 cm <sup>3</sup> )
Frame Section Modulus (SM) over rear stabilizers: 110,000 PSI (758 MPa)	13.0 in <sup>3</sup> (213.0 cm <sup>3</sup> )
Stability Weight, Front	8,500 lb (3856 kg) minimum*
Stability Weight, Rear	9,100 lb (4128 kg) minimum*
Estimated Average Final Weight	40,800 lb (18 507 kg)

This configuration allows the installation of the Series 8100D on a chassis by using the subbase for a 22-ft. (6.71-m) bed.

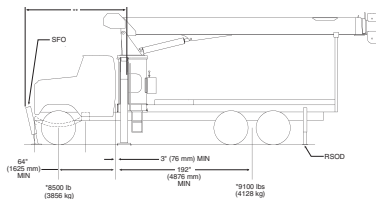

## Configuration 2 – 8100D (add SFO for 360° stability)

Working area	360°
Gross Axle Weight Rating Front	16,000 lb (7257 kg)
Gross Axle Weight Rating Rear	34,000 lb (15 422 kg)
Gross Vehicle Weight Rating	50,000 lb (22 679 kg)
Wheelbase	256 in (650 cm)
Cab to Axle/trunnion (CA/CT)	192 in (488 cm)
Frame Section Modulus (SM) under crane: 110,000 PSI (758 MPa)	20.0 in <sup>3</sup> (327.7 cm <sup>3</sup> )
Frame Section Modulus (SM) over rear stabilizers: 110,000 PSI (758 MPa)	13.0 in <sup>3</sup> (213.0 cm <sup>3</sup> )
Stability Weight, Front	8,500 lb (3856 kg) minimum*
Stability Weight, Rear	9,100 lb (4128 kg) minimum*
Estimated Average Final Weight	41,200 lb (18 688 kg)

This mount requires front stabilizer for full capacity 360° around the truck. Front stabilizer gives the machine a solid base. This configuration requires a 22-ft. (6.71-m) bed for rear overhang, and extended front frame rails for SFO mounting.

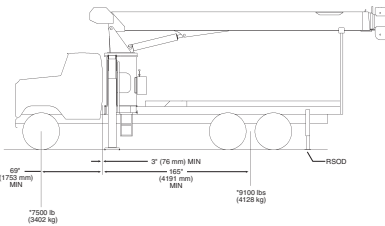

## Configuration 3 – All boom lengths, other than 8100D

Working area	180°
Gross Axle Weight Rating Front	16,000 lb (7257 kg)
Gross Axle Weight Rating Rear	34,000 lb (15 422 kg)
Gross Vehicle Weight Rating	50,000 lb (22 679 kg)
Wheelbase	234 in (594 cm)
Cab to Axle/trunnion (CA/CT)	165 in (419 cm)
Frame Section Modulus (SM) under crane w/110,000 PSI (758 MPa)	15.9 in <sup>3</sup> (260.6 cm <sup>3</sup> )
Frame Section Modulus (SM) over rear stabilizers: 110,000 PSI (758 MPa)	13.0 in <sup>3</sup> (213.0 cm <sup>3</sup> )
Stability Weight, Front	7,500 lb (3402 kg) minimum*
Stability Weight, Rear	9,100 lb (4128 kg) minimum*
Estimated Average Final Weight (890D)	38,800 lb (17 600 kg)**

This configuration allows the installation of the Series 800D on a chassis with a subbase and bed combination which best fits the boom length. Depending on the boom length, the bed can be 18', 20' or 22'. Not all bed lengths can be used with each boom due to rear overhang limits.

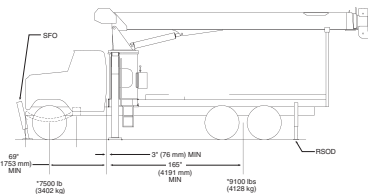

## Configuration 4 – All boom lengths, other than 8100D

Working area	360°
Gross Axle Weight Rating Front	16,000 lb (7257 kg)
Gross Axle Weight Rating Rear	34,000 lb (15 422 kg)
Gross Vehicle Weight Rating	50,000 lb (22 679 kg)
Wheelbase	234 in (594 cm)
Cab to Axle/trunnion (CA/CT)	165 in (419 cm)
Frame Section Modulus (SM) under crane w/110,000 PSI (758 MPa)	20 in <sup>3</sup> (327.7 cm <sup>3</sup> )
Frame Section Modulus (SM) over rear stabilizers: 110,000 PSI (758 MPa)	13 in <sup>3</sup> (213.0 cm <sup>3</sup> )
Stability Weight, Front	7,500 lb (3402 kg) minimum*
Stability Weight, Rear	9,100 lb (4128 kg) minimum*
Estimated Average Final Weight (890D)	39,200 lb (17 780 kg)

This mount requires front stabilizer for full capacity 360° around the truck. Front stabilizer gives the machine a solid base. Bed length and subbase combinations must match boom length to limit rear overhang. Extended front frame rails required for SFO mounting.

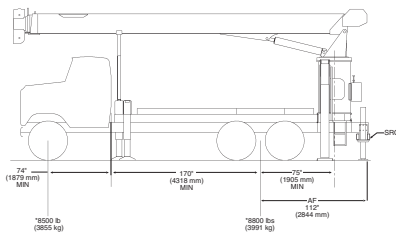

## Configuration 5 – Rear Mount (all boom lengths)

Working area	360°
Gross Axle Weight Rating Front	16,000 lb (7257 kg)
Gross Axle Weight Rating Rear	40,000 lb (18 143 kg)
Gross Vehicle Weight Rating	56,000 lb (25 401 kg)
Wheelbase	244 in (620 cm)
Cab to Axle/trunnion (CA/CT)	170 in (432 cm)
Frame Section Modulus (SM) under crane: 110,000 PSI (758 MPa)	15.9 in <sup>3</sup> (260.6 cm <sup>3</sup> )
Stability Weight, Front	8,500 lb (3856 kg) minimum*
Stability Weight, Rear	8,800 lb (3991 kg) minimum*
Estimated Average Final Weight (8100D)	43,000 lb (19 504 kg)

This configuration allows the rear-mount installation of the Series 800D. This configuration is 360° stable and allows the effective use of close working area to lift the heavier capacity loads. Maximum bed length is 16' (4.87 m). Requires single rear outrigger.

### Notes:

- Gross Vehicle Weight rating (GVWR) is dependent on all components of the vehicle (axles, tires, springs, frame, etc.) meeting manufacturers' recommendations; always specify GVWR when purchasing trucks
- Diesel engines require a variable speed governor and energize-to-run fuel solenoid for smooth crane operation; electronic fuel injection requires EET engine remote throttle

- All mounting data is based on a National Series 800D with an 85 percent stability factor
- The complete unit must be installed in accordance with factory requirements, and a test performed to determine actual stability and counterweight requirements per SAE J765; contact the factory for details
- Transmission neutral safety interlock switch is required with optional remote control

\*Estimated axle scale weights prior to installation of crane, stabilizers and subbase for 85% stability.  
 \*\*If the distance from the front bumper (SFO) to center of rotation exceeds 144 inches (366 cm), the 40-ft (12.19 m) overall truck length restriction will be exceeded. Overall length restrictions vary from state to state. In some states it is legal to be more than 40 ft (12.19 m) in length, and some states allow overlength permits.

800D

# specifications

## Boom and Jib Combinations Data

Available in four basic models.

4

**Model 851D** – Equipped with a 21 ft. to 51 ft. (6.4-15.5 m) three-section boom. Maximum tip height is 62 ft. (18.9 m).



**Model 880D** – Equipped with a 24 ft. 6 in. to 80 ft. (7.46-24.38 m) four-section boom. This model can be equipped with a 22-39 ft. (6.70-11.88 m) two-section jib. Maximum tip height w/39 ft. (11.88 m) jib is 128 ft. (39.01 m).

24'6"-80' (7.46-24.38 m) four-section boom.



24'6"-80' (7.46-24.38 m) four-section boom. **8FJ39M** 22-39 ft. (6.70-11.88 m) two-section jib



**Model 890D** – Equipped with a 27 ft. to 90 ft. (8.23-27.43 m) four-section boom. This model can be equipped with a 25-44 ft. (7.62-13.41 m) two-section jib. Maximum tip height w/44 ft. (13.41 m) jib is 143 ft. (43.58 m).

27'-90' (8.23-27.43 m) four-section boom.



27'-90' (8.23-27.43 m) four-section boom. **8FJ44M** 25-44 ft. (7.62-13.41 m) two-section jib



**Model 8100D** – Equipped with a 29 ft. 6 in. to 100 ft. (8.99-30.48 m) four-section boom. This model can be equipped with a 25-44 ft. (7.62-13.41 m) two-section jib. Maximum tip height w/44 ft. (13.41 m) jib is 152 ft. (46.32 m).

29'6" - 100' (8.99-30.48 m) four-section boom.



29'6" - 100' (8.99-30.48 m) four-section boom. **8FJ44M** 25-44 ft. (7.62-13.41 m) two-section jib



**Note:** Maximum tip is measured with outriggers/stabilizers fully extended.

## 800D Winch Data

### 800D Winch Data

- All winch pulls and speeds in this chart are shown on the **fourth** layer
- Winch line pulls would increase on the first, second and third layers
- Winch line speed would decrease on the first, second and third layers
- Winch line pulls may be limited by the winch capacity or the ANSI 5 to 1 cable safety factor
- Hook blocks are rated at maximum capacity for the block. **Do not exceed rated cable pull with any block.**

Winch	Cable Supplied	Average Breaking Strength	1 Part Line	2 Part Line	3 Part Line	4 Part Line	5 Part Line	6 Part Line
			Lift and Speed	Lift and Speed	Lift and Speed	Lift and Speed	Lift and Speed	Lift and Speed
Standard Planetary Winch	9/16" Diameter Rotation Resistant	38,600 lb (17,463 kg)	7,700 lb (3492 kg) 147 fpm (45 m/min)	15,400 lb (6,985 kg) 73 fpm (22 m/m)	23,100 lb (10,477 kg) 49 fpm (15 m/m)	30,800 lb (13,970 kg) 38 fpm (11 m/m)	38,500 lb (17,163 kg) 29 fpm (9 m/m)	46,000 lb (20,865 kg) 25 fpm (8 m/m)
With "Burst-of-Speed"	Same as corresponding cable data shown above		3,000 lb (1360 kg) 206 fpm (62 m/m)	6,000 lb (2721kg) 103 fpm (31 m/m)	9,000 lb (4082 kg) 68 fpm (20 m/m)	12,000 lb (5443 kg) 51 fpm (15 m/m)	15,000 lb (6803 kg) 41 fpm (12 m/m)	18,000 lb (8164 kg) 34 fpm (10 m/m)

Block Type	Rating	Weight
Downhaul Weight.....	3.85 ton (3.49 t).....	150 lb (68 kg)
1 Sheave Block.....	11.55 ton (10.48 t).....	305 lb (138 kg)
2 Sheave Block.....	19.25 ton (17.46 t).....	355 lb (161 kg)
3 Sheave Block.....	30.00 ton (27.21 t).....	575 lb (261 kg)

Winch	Bare Drum Pull	Allowable Cable Pull
With standard rotation resistant rope.....	10,200 lb (4627 kg).....	7,700 lb (3493 kg)

800D

# capacities

## Load Rating Chart: Series 8100D with 44 ft. Jib

Other series 800D Load Rating Charts are available. National will send you a chart on request – or you may secure needed load rating information through your nearest National dealer.

5

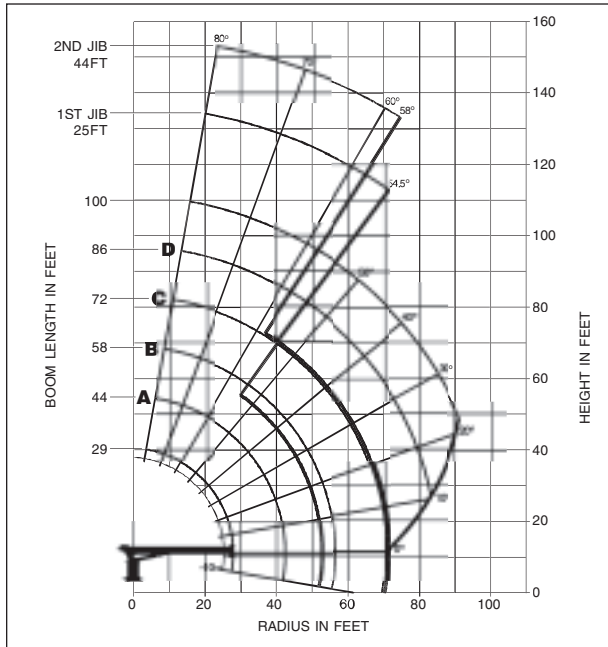

### CAUTION:

- Do not operate crane booms, jib extensions, any accessories or loads within 10 ft (3m) of live power lines or other conductors of electricity.
- Jib and boom capacities shown are maximum for each section.
- Do not exceed capacities at reduced radii
- Load ratings shown on the load rating charts are maximum allowable loads with the outriggers properly extended on a firm, level surface and the crane leveled and mounted on a factory recommended truck.
- Always level the crane with the level indicator located on the crane.
- The operator must reduce load to allow for factors such as wind, ground conditions, operating speeds and their effects on freely suspended loads.
- Overloading this crane may cause structural collapse or instability.
- Weights on any accessories attached to the boom or loadline must be deducted from the load chart capacities.
- Do not exceed jib capabilities at any reduced boom lengths.
- Do not deadhead lineblock against boom tip when extending boom or winching up.
- Keep at least three wraps of loadline on drum at all times.
- Use only specified cable with this machine.

### SERIES 8100D WITH 44 FT JIB

### NOTE:

1. Operate with jib by radius when main boom is fully extended. If necessary increase boom angle to maintain loaded radius.
2. Operate with jib by boom angle when main boom is not fully extended. Do not exceed rated jib capacities at any reduced boom lengths.

### LMI OPERATING CODE

OPERATING MODE	
01	Main Boom - No Jib Stowed
02	Main Boom - Jib Stowed
03	25 ft Tele Jib
04	44 ft Tele Jib
11	Man Basket On Main Boom
12	Man Basket On 25 ft Tele Jib
13	Man Basket On 44 ft Tele Jib

## Load Rating: Series 8100D with 44 ft. Jib

LOAD RADIUS (FEET)	LOADED BOOM ANGLE	29FT BOOM (lb)	LOADED BOOM ANGLE	A 44FT BOOM (lb)	LOADED BOOM ANGLE	B 58FT BOOM (lb)	LOADED BOOM ANGLE	C 72FT BOOM (lb)	LOADED BOOM ANGLE	D 86FT BOOM (lb)	LOADED BOOM ANGLE	100FT BOOM (lb)	LOAD RADIUS (FEET)	LOADED BOOM ANGLE	25FT JIB (lb)	LOADED BOOM ANGLE	44FT JIB (lb)
5	79	46,000											30	78	3,900	80	2,750
8	72.5	30,700	79	27,900									35	75.5	3,400	78	2,500
10	68	25,500	76	23,200									40	73	2,800	76	2,250
12	63.5	21,800	73.5	19,700	78	18,050							45	70.5	2,350	74	2,000
14	59	19,000	70.5	17,200	76	15,750	79.5	14,350					50	68	1,850	72	1,850
16	54	16,700	68	15,200	74	13,850	77.5	12,650					55	65	1,500	70	1,600
20	43	13,400	61	12,200	69.5	11,250	74.5	10,350	77.5	9,550	80	7,450	60	62.5	1,300	67.5	1,350
25	25	9,700	54	9,700	64	8,950	70	8,250	74	7,650	77	7,100	65	60	1,100	65	1,050
30			45	7,900	58.5	7,350	66	6,650	70.5	6,150	74	5,850	70	57	750	63	950
35			35	6,300	53	6,100	61.5	5,600	67	5,200	71	4,900	75	54.5	600	60.5	800
40			20	4,600	46	5,100	56.5	4,750	63	4,400	67.5	4,250	80			58	600
45					38	4,250	51.5	4,050	59.5	3,800	64.5	3,650					
50					28.5	3,400	46	3,450	55	3,250	61	3,150					
55					14	2,200	40	2,900	51	2,800	57.5	2,650					
60							33	2,350	46.5	2,400	54	2,300					
65							24	1,800	41	2,000	50	1,850					
70							6.5	700	35.5	1,600	46	1,650					
75									29	1,250	42	1,350					
80									20	800	37	1,050					
85											32	800					
90											25	500					
	0	5,100	0	2,300	0	950											

### LOADLINE EQUIPMENT DEDUCT ( lb )

- Downhaul weight \_\_\_\_\_ 150
- One sheave block \_\_\_\_\_ 305
- Two sheave block \_\_\_\_\_ 355
- Three sheave block \_\_\_\_\_ 575

THIS CHART IS ONLY A GUIDE AND SHOULD NOT BE USED TO OPERATE THE CRANE. The individual crane's load chart, operating instructions and other instructional plates must be read and understood prior to operating the crane.

# capacities

## Load Rating Chart: Series 8100D with No Jib

6

Other series 8100D Load Rating Charts are available. National will send you a chart on request – or you may secure needed load rating information through your nearest National dealer.

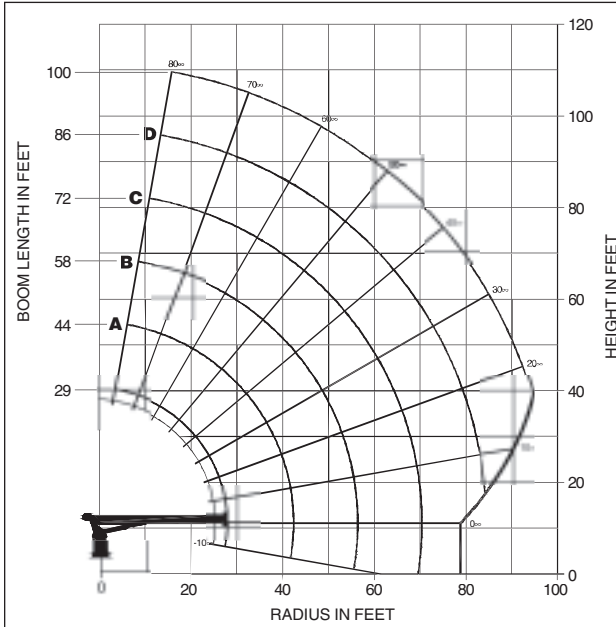

### CAUTION:

- Do not operate crane booms, jib extensions, any accessories or loads within 10 ft (3m) of live power lines or other conductors of electricity.
- Jib and boom capacities shown are maximum for each section.
- Do not exceed capacities at reduced radii
- Load ratings shown on the load rating charts are maximum allowable loads with the outriggers properly extended on a firm, level surface and the crane leveled and mounted on a factory recommended truck.
- Always level the crane with the level indicator located on the crane.
- The operator must reduce load to allow for factors such as wind, ground conditions, operating speeds and their effects on freely suspended loads.
- Overloading this crane may cause structural collapse or instability.
- Weights on any accessories attached to the boom or loadline must be deducted from the load chart capacities.
- Do not exceed jib capabilities at any reduced boom lengths.
- Do not deadhead lineblock against boom tip when extending boom or winching up.
- Keep at least three wraps of loadline on drum at all times.
- Use only specified cable with this machine.

**SERIES 8100D  
WITH  
NO JIB**

### LOADLINE EQUIPMENT DEDUCT ( lb )

Downhaul weight	_____	150
One sheave block	_____	305
Two sheave block	_____	355
Three sheave block	_____	575

## Load Rating Chart: Series 8100D with No Jib

LOAD RADIUS (FEET)	LOADED BOOM ANGLE	29FT BOOM (lb)	LOADED BOOM ANGLE	A 44FT BOOM (lb)	LOADED BOOM ANGLE	B 58FT BOOM (lb)	LOADED BOOM ANGLE	C 72FT BOOM (lb)	LOADED BOOM ANGLE	D 86FT BOOM (lb)	LOADED BOOM ANGLE	100FT BOOM (lb)
5	79	46,000										
8	72.5	31,500	79	28,500								
10	68	26,300	76	23,800								
12	63.5	22,600	73.5	20,300	78	18,500						
14	59	19,800	70.5	17,800	76	16,200	79.5	14,700				
16	54	17,500	68	15,800	74	14,300	77.5	13,000				
20	43	14,200	61	12,800	69.5	11,700	74.5	10,700	77.5	9,850		
25	25	10,500	54	10,300	64	9,400	70	8,600	74	7,950	77	7,350
30			45	8,500	58.5	7,800	66	7,000	70.5	6,450	74	6,100
35			35	6,900	53	6,550	61.5	5,950	67	5,500	71	5,150
40			20	5,200	46	5,550	56.5	5,100	63	4,700	67.5	4,500
45					38	4,700	51.5	4,400	59.5	4,100	64.5	3,900
50					28.5	3,850	46	3,800	55	3,550	61	3,400
55					14	2,650	40	3,250	51	3,100	57.5	2,900
60							33	2,700	46.5	2,700	54	2,550
65							24	2,150	41	2,300	50	2,100
70							6.5	1,050	35.5	1,900	46	1,900
75									29	1,550	42	1,600
80									20	1,100	37	1,300
85											32	1,050
90											25	750
	0	5,900	0	2,900	0	1,400	0	500				

THIS CHART IS ONLY A GUIDE AND SHOULD NOT BE USED TO OPERATE THE CRANE. The individual crane's load chart, operating instructions and other instructional plates must be read and understood prior to operating the crane.

**800D**

# accessories

7

## Radio Remote Controls –

Eliminate the handling and maintenance concerns that accompany cabled remotes. Operate to a range of about 250 feet (76 m), varying with conditions.

• **Model NB4R**

## One-Person Basket –

Strong but lightweight steel basket with 300-lb (139-kg) capacity, gravity hung with swing lock and full body harness.

• **Model B1-S**  
• **Model 2B1-S** (for dual locking baskets)

## Heavy-duty Personnel Basket –

1,200-lb. (544-kg) capacity steel basket with safety loops for four passengers. Gravity leveling 72- x 42-inch (183- x 107-cm) platform. Fast attachment and secure locking systems. Load chart must show 2,300 lb. (1043 kg) minimum to operate this accessory.

• **Model BSA-1**  
• **Model BSA-R1** (provides rotation)

## Hydraulic Oil Cooler –

Automatic, self-contained radiator system with electric fans cools oil under continuous operation.

• **Model OC**

## Continuous Rotation –

Allows rotation of turret/boom without rotation stop.

• **Model CR**

## Dimensions Specifications

SERIES	G in (mm)	DRY WEIGHT lb (kg)	WITH OIL/WT lb (kg)
851D	28 (686)	13700 (6214)*	14215 (6448)*
880D	56 (1422)	18475 (8380)*	18995 (8615)*
890D	68 (1730)	19640 (8908)**	20160(9144)**
8100D	79 (2010)	20635 (9360)***	211585 (9596)***

\*\*\*INCLUDES STANDARD 18' SUBBASE  
\*\*INCLUDES STANDARD 20' SUBBASE  
\*INCLUDES STANDARD 22' SUBBASE

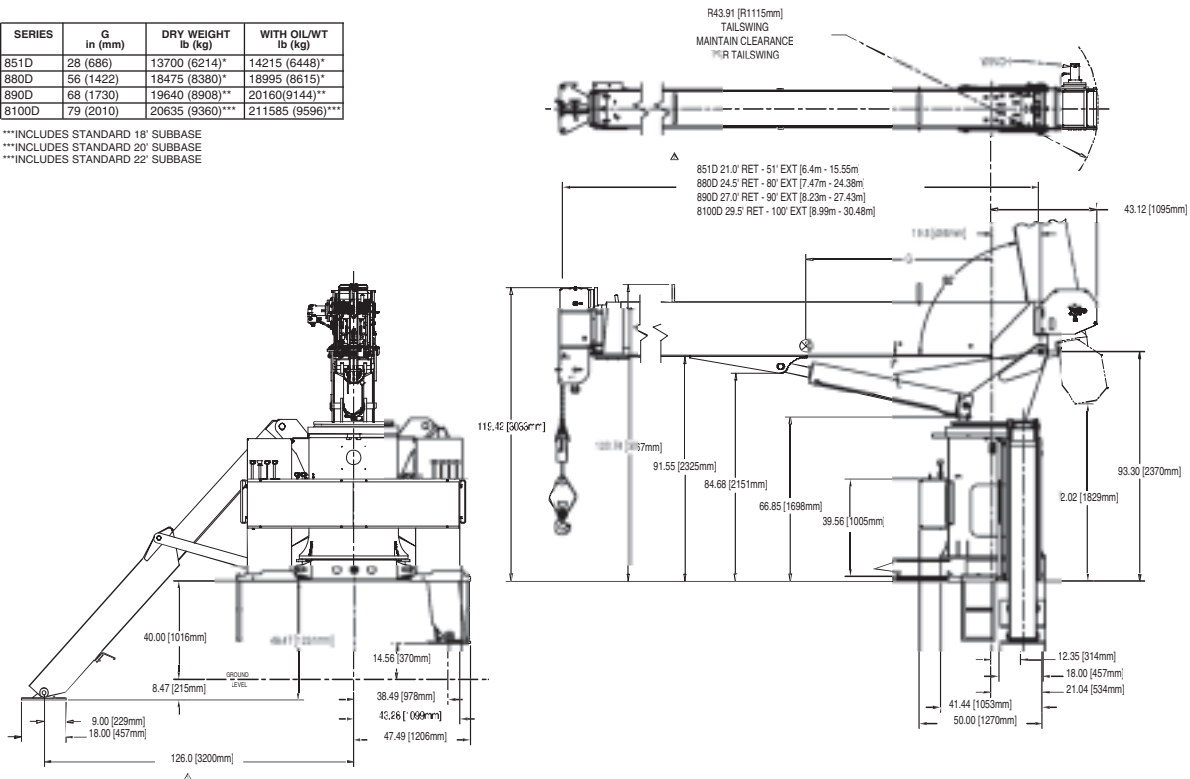

800D



**Manitowoc Crane Group - Americas**

Manitowoc, Wisconsin Facility  
Tel: [Int + 001] 920 684 6621  
Fax: [Int + 001] 920 683 6277  
Shady Grove, Pennsylvania Facility  
Tel: [Int + 001] 717 597 8121  
Fax: [Int + 001] 717 597 4062

**Manitowoc Crane Group - EMEA**

Europe Middle East & Africa  
Tel: [Int + 33] (0) 191 565 6281  
Fax: [Int + 33] (0) 4 72 18 20 20

**Manitowoc Crane Group - UK**

Europe Middle East & Africa  
Tel: [Int + 44] (0) 191 565 6281  
Fax: [Int + 44] (0) 191 564 0442

**Manitowoc Crane Group - Germany**

(Sales, Parts & Service)  
Tel: [Int + 49](0) 2173 8909 0  
Fax: [Int + 49] (0) 2173 8909-30

**Manitowoc Crane Group - France**

France & Africa (Sales, Parts & Service)  
Tel: [Int + 33] (0) 1 303 13150  
Fax: [Int + 33] (0) 1 303 86085

**Manitowoc Crane Group - Netherlands**

(Sales, Parts & Service)  
Tel: [Int + 31] (0) 76 578 39 99  
Fax: [Int + 31] (0) 76 578 39 78

**Manitowoc Crane Group - Italy**

Italy & Southern Europe (Sales, Parts & Service)  
Tel: [Int + 39] (0) 331 49 33 11  
Fax: [Int + 39] (0) 331 49 33 30

**Manitowoc Crane Group - Portugal**

Portugal & Spain (Sales, Parts & Service)  
Tel: [Int + 351] (0) 22 968 08 89  
Fax: [Int + 351] (0) 22 968 08 97

**Manitowoc Crane Group - Singapore**

Asia/Pacific excl China (Sales, Parts & Service)  
Tel: [Int + 65] 6861 1733  
Fax: [Int + 65] 6862 4040 / 4142

**Manitowoc Crane Group - Shanghai**

China (Sales, Parts & Service)  
Tel: [Int + 86] (0) 21 64955555  
Fax: [Int + 86] (0) 2164852038

**Manitowoc Crane Group - Beijing**

China (Sales, Parts & Service)  
Tel: [Int + 86] (0) 10 646 71690  
Fax: [Int + 86] (0) 10 646 71691

**Manitowoc Crane Group - Middle East**

Sales  
Tel: [Int + 971] (0) 4 348 4478  
Fax: [Int + 971] (0) 4 348 4478  
(Parts & Service)  
Tel: [Int + 973] (0) 9 660 899  
Fax: [Int + 973] (0) 2 707 740

**Distributed By:**



[www.manitowoccrane.com](http://www.manitowoccrane.com)

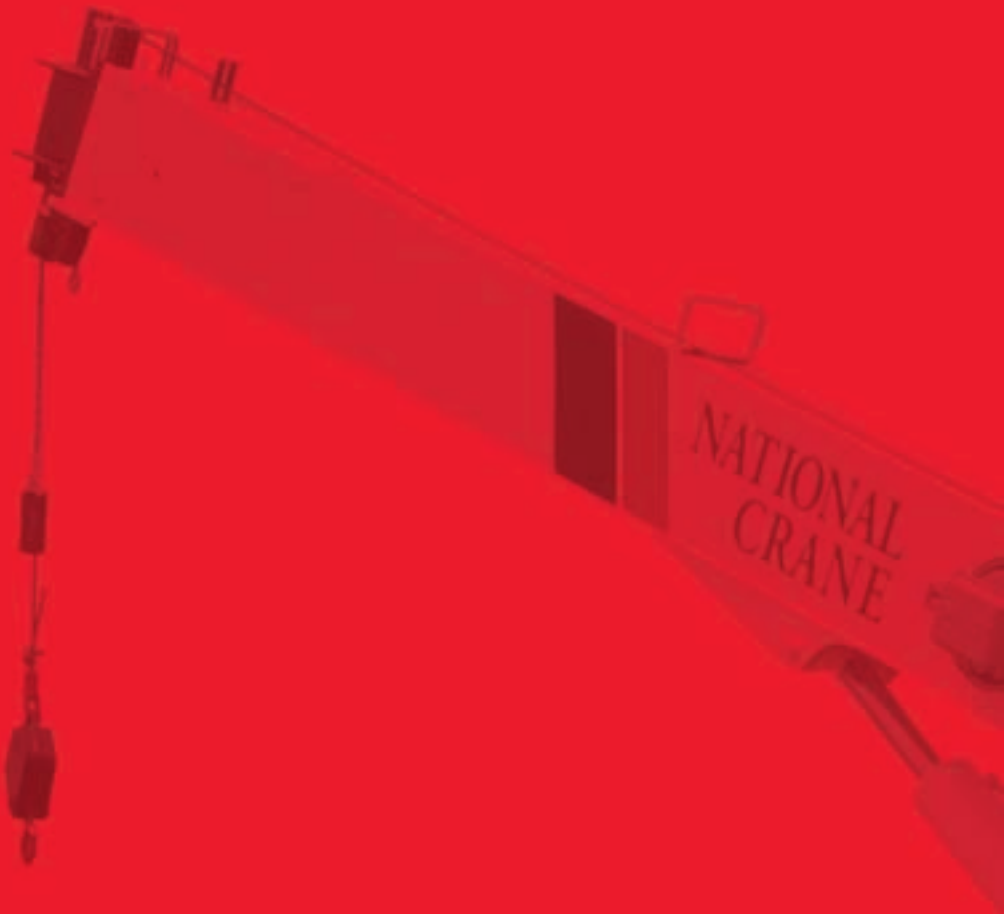

Constant improvement and engineering progress make it necessary that we reserve the right to make specification, equipment, and price changes without notice. Illustrations shown may include optional equipment and accessories, and may not include all standard equipment.